

MURA 360**60W VOLUME ATTENUATOR FOR 70-100V SPEAKERS,
11 POSITIONS + OFF, WITH AUXILIARY LINE AND 24V
ALARM CONTROL**

The MURA 3 Series in-wall mount Volume Controllers are designed to be installed within normal 503-standard wall boxes (108x53,5x74mm, not supplied). They allow control of the volume with, respectively, 4 positions + off for MURA 305, and 11 positions + off for MURA 310/330/360. The max. nominal powers range from 2.5W to 30W in case of 70V lines; and 5W to 60W for 100V lines.

Each position attenuates the overall level from 5dB to 10dB, depending on the model. However, all they provide, in addition to the normal 70-100V audio line, the 70-100V auxiliary line at maximum level (the attenuation does not operate in this case but passes the whole signal to the speaker) and the 24V relay input for switching between normal and auxiliary line in case of alarm. The MURA 3 Series is supplied with a front cover plate (white) and is compatible with BTicino® Matix®

3P plates.

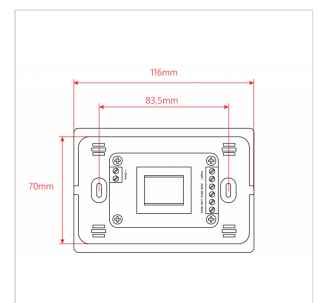
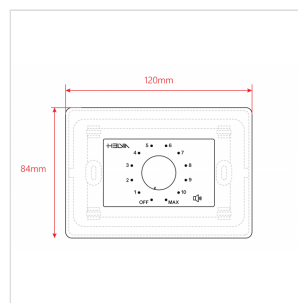

MURA 360

**60W VOLUME ATTENUATOR FOR 70-100V SPEAKERS,
11 POSITIONS + OFF, WITH AUXILIARY LINE AND 24V
ALARM CONTROL**

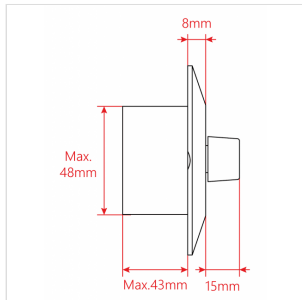

MURA 360

60W VOLUME ATTENUATOR FOR 70-100V SPEAKERS, 11 POSITIONS + OFF, WITH AUXILIARY LINE AND 24V ALARM CONTROL

PRODUCT DETAILS

KEY FEATURES

70V and 100V Constant Voltage Audio Line Operation

503-Standard Compatible (scatola incasso 108 x 53,5 x 74 mm, not inclusa)

11 Positions (5dB attenuation) + Off

Auxiliary 70-100V Line with 24V relay control

Front Cover Included (White)

SPECIFICATIONS

Nominal Power @ 100V 60W

Nominal Power @ 70V 30W

Control 11 Positions + Off

Step Attenuation 5dB

Total Attenuation 55dB

In-Wall Mount Box 503 Standard - 108 x 53,5 x 74 mm - 4.25 x 2.10 x 2.91 in (not Included)

Front Cover White (Included)

Dimensions 120 x 48 (max.) x 84 mm - 4.72 x 1.89 (max.) x 3.30 in

Net Weight 180 g - 0.40 lbs.

Packing Size 122 x 72 x 84,5 mm - 4.80 x 2.83 x 3.33 in

Gross Weight 210 g - 0.46 lbs.