

MURA 260

60W VOLUME ATTENUATOR FOR 70-100V SPEAKERS, 11 POSITIONS + OFF, WITH AUXILIARY LINE AND 24V ALARM CONTROL

The MURA 2 Serie in-wall Volume Controllers offers a range of volume attenuators for 70V and 100V audio systems and are designed to be recessed in 82x82x48mm wall boxes (supplied). They allow control of the volume with, respectively, 4 positions + off for MURA 205, and 11 positions + off for MURA 210/230/260. The max. nominal powers range from 2.5W to 30W in case of 70V lines; and 5W to 60W for 100V lines.

Each position attenuates the overall level from 5dB to 10dB, depending on the model. MURA 210/230/260 provide, in addition to the normal 70-100V audio line, the 70-100V auxiliary line at maximum level (the attenuation does not operate in this case but passes the whole signal to the speaker) and the 24V relay input for switching between normal and auxiliary line in case of alarm.

MURA 2 Series volume controllers are supplied with the front cover plate (white) and the in-wall box.

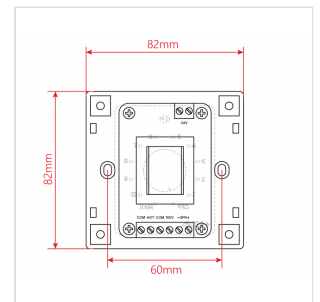
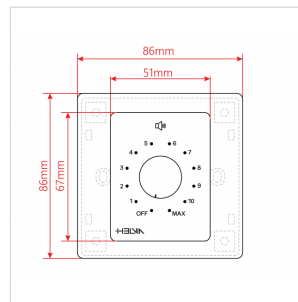
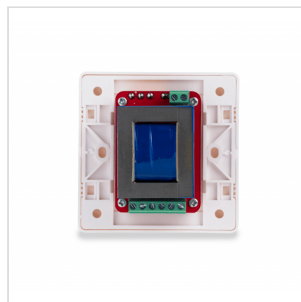

MURA 260

60W VOLUME ATTENUATOR FOR 70-100V SPEAKERS, 11 POSITIONS + OFF, WITH AUXILIARY LINE AND 24V ALARM CONTROL

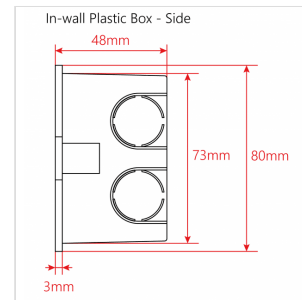
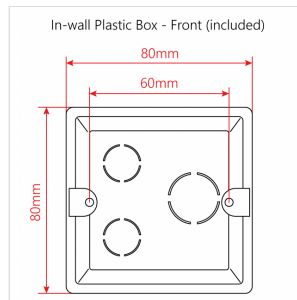
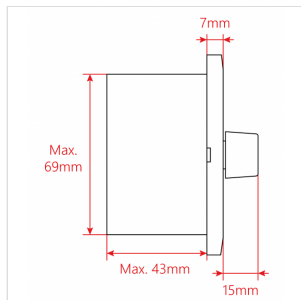

MURA 260

60W VOLUME ATTENUATOR FOR 70-100V SPEAKERS, 11 POSITIONS + OFF, WITH AUXILIARY LINE AND 24V ALARM CONTROL

PRODUCT DETAILS

KEY FEATURES

70V and 100V Constant Voltage Audio Line Operation

11 Positions (5dB attenuation) + Off

Auxiliary 70-100V Line with 24V relay control

Front Cover Included (White)

In-Wall Mount Box Included

SPECIFICATIONS

Nominal Power @ 100V	60W
Nominal Power @ 70V	30W
Control	11 Positions + Off
Step Attenuation	5dB
Total Attenuation	55dB
In-Wall Mount Box	80 x 80 x 48 mm (Included) - 3.15 x 3.15 x 1.89 in
Front Cover	White (Included)
Dimensions	82 x 43 (max.) x 82 mm - 3.23 x 1.7 (max.) x 3.23 in
Net Weight	180 g - 0.40 lbs.
Packing Size	87 x 45 x 87 mm - 3.4 x 1.8 x 3.4 in
Gross Weight	210 g - 0.46 lbs.